

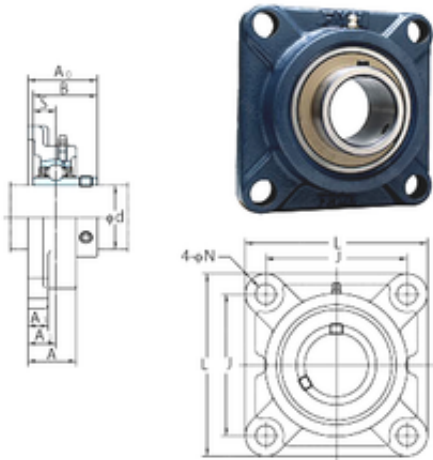

NTN Bearing Driveshaft do Brasil



FYH UCF208-24 bearing units

Bearing No. UCF208-24

Bore Diameter	38,1 mm
d	38,1 mm
A0	51,2 mm
A	36 mm
A1	15 mm
B	49,2 mm
J	102 mm
L	130 mm
N	16 mm
S	19 mm
Bolt (G)	M14
A2	21 mm
Weight	1,9 Kg
Basic dynamic load rating (C)	29,1 kN
Basic static load rating (C0)	17,8 kN

UCF208-24 Bearing 2D drawings and 3D CAD models